

---

---

# **KG934V1 Genset Controller User Manual**



Enriching Lives

## **KIRLOSKAR OIL ENGINES LIMITED**

Laxmanrao Kirloskar Road, Khadki, Pune-411 003, India.

Tel : +91(20) 2581 0341

Fax: +91(20) 2581 3208/ 2581 0209

[www.kirloskar.com](http://www.kirloskar.com)

The information contained in this document is copyright, and shall not be reproduced without the written authority of KOEL  
©2010

## KG934V1

### Genset Controller

#### 1. Introduction

The KG934V1 is an integrated Engine and AC controller for small gensets. It is a custom unit specifically designed and manufactured for Kirloskar Oil Engines Ltd.

The unit incorporates both manual and autostart initiated start and stop sequencing, monitors engine and alternator operating parameters and provides both engine and alternator protection, in a single integrated package.

The genset operating parameters are shown by scrolling screens on a backlit 128 x 64 dot Graphics LCD. Alarms and warning are also shown on the LCD and supplemented by an alarm LED and Hooter output.

The unit provides comprehensive monitoring of the engine and generator operating parameters and provides automatic shutdown of the genset in the event of damaging conditions. In addition to the usual engine safety protections the unit monitors coolant level, fuel level, canopy temperature and generator loading to provide even more comprehensive protection.

In the factory environment, the unit is configured by cloning through a PC system. Field specific parameters can be adjusted by using the front panel buttons and an inbuilt menu system.

#### 2. Benefits

- Reduces system cost:
- Integrates engine gauges and AC metering into one unit.
- Minimises control panel wiring offering reduced material and labour costs.
- Reduces warranty costs by providing comprehensive engine and generator protection and a maintenance due timer.
- Flexible, the unit can be customised by PC cloning with application codes for individual genset model characteristics and fitments.

# KG934V1 User Manual



## 3. Physical Form

### Front View

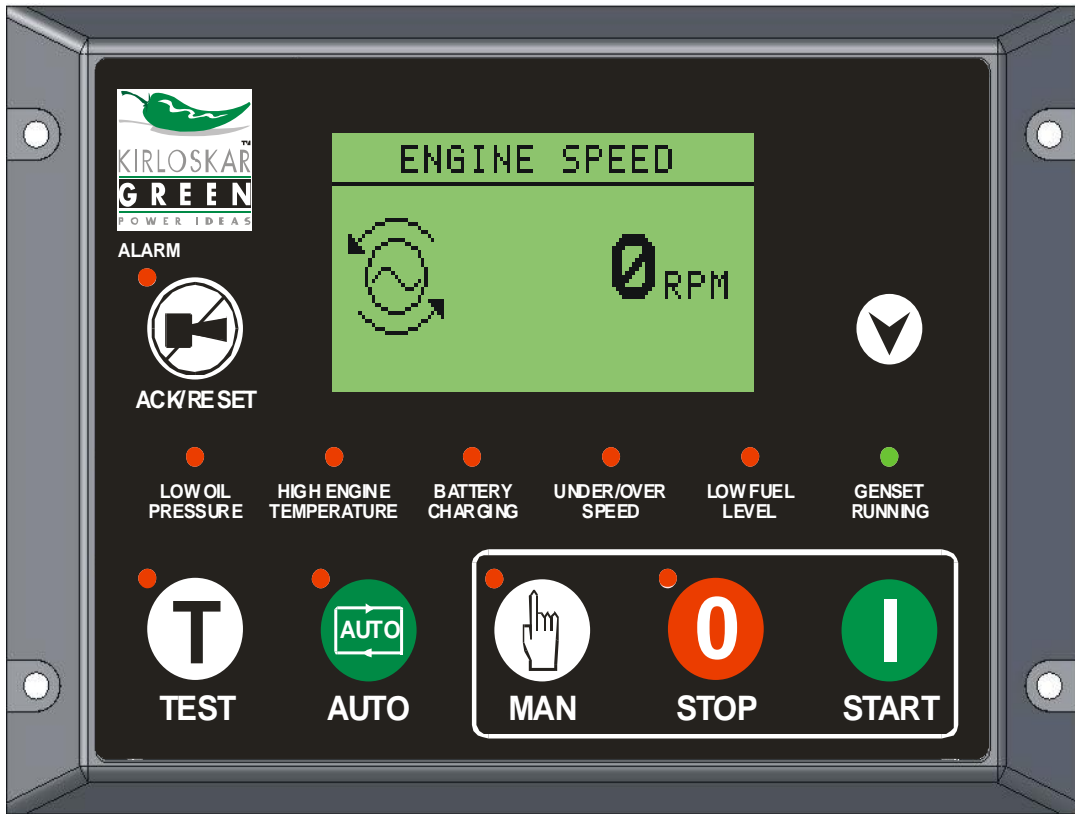

### Back View

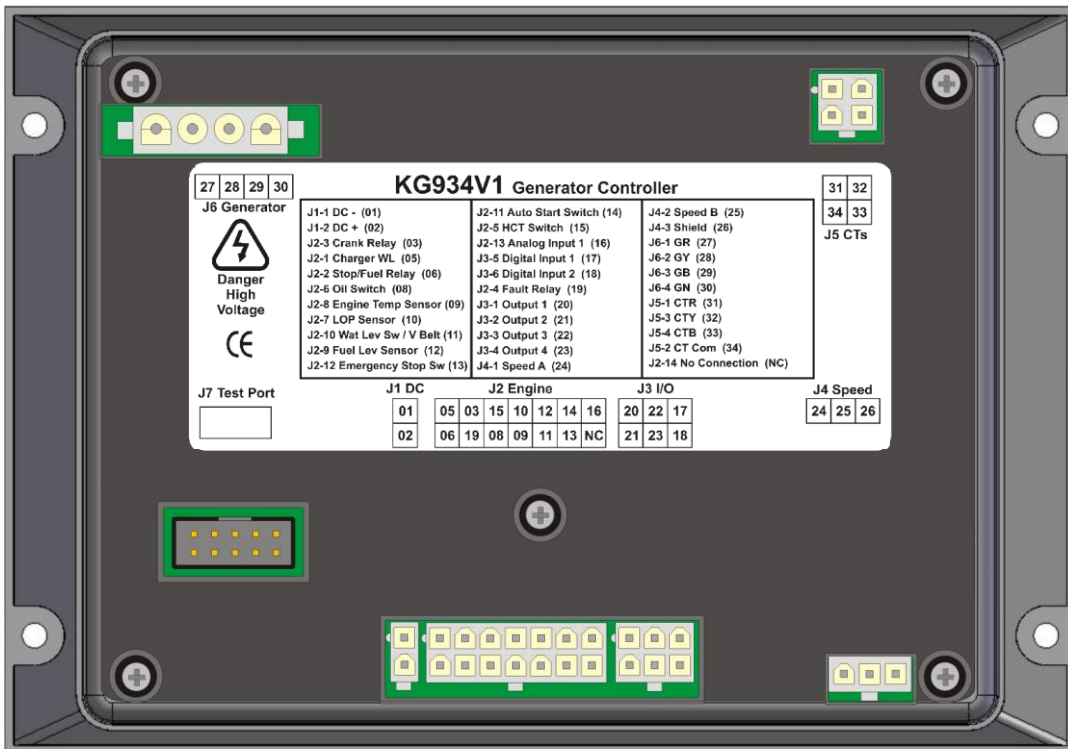

# KG934V1 User Manual



## Functions

### System

Function	Description
Protection Shutdown	Automatic preventative engine and genset shutdown in the event of abnormal operating conditions with optional configuration parameters and clear LCD status messages
Manual Start	In response to the front panel pushbutton performs a fully sequenced engine start with optional configuration parameters and clear LCD status messages
Manual Stop	In response to the front panel pushbutton performs a fully sequenced engine stop with optional configuration parameters and clear LCD status messages
Auto Start Stop	In response to a digital input activation the unit performs a fully sequenced engine start. Deactivating the input performs a fully sequenced engine cool down then stop. Contactors, if used, are also fully sequenced for changing the load between Mains and DG..
Emergency Stop	In response to a digital input performs a fully sequenced engine stop with optional configuration parameters and clear LCD status messages

### Engine Monitoring

Function	Description
Over / Under Speed	Monitors engine speed with optional configuration parameters and clear LCD status messages this ensures the engine speed remains within configured limits. Exceeding these limits will result in automatic engine shutdown to prevent damage.
Lubrication Oil Pressure	Monitors engine oil pressure with optional configuration parameters and clear LCD status messages this ensures the oil pressure remains within configured limits. Exceeding these limits will result in automatic engine shutdown to prevent damage.
Engine Temperature	Monitors engine temperature with optional configuration parameters and clear LCD status messages this ensures the engine temperature remains within configured limits. Exceeding these limits will result in automatic engine shutdown to prevent damage.
Battery Voltage	Monitors engine battery voltage with optional configuration parameters and clear LCD status messages this ensures the battery voltage remains within configured limits.
Battery Charging	Monitors engine battery charging status and clear LCD status messages this ensures the battery is charged when the engine is running.
Radiator Water Level	Monitors engine radiator water minimum level with clear LCD status messages this ensures the radiator water level remains sufficient. Low water will result in automatic engine shutdown to prevent damage.
Fuel Level	Monitors engine fuel level with clear LCD status messages. Low fuel level will result in automatic engine shutdown to prevent damage.
Canopy Temperature	Monitors an engine canopy temperature switch with clear LCD status messages. This function will result in automatic engine shutdown to prevent damage.
Running Hours	Records engine run hours with clear LCD status messages.

# KG934V1 User Manual



## Generator Monitoring

Function	Description
AC Phase Voltage	Monitors Genset 1, 2 or 3 phases of AC voltage with optional configuration parameters and clear LCD status messages.
AC Phase Current	Monitors Genset 1, 2 or 3 phases of AC current with optional configuration parameters and clear LCD status messages. <b>Uses externally fitted 5A CTs.</b>
AC Phase Frequency	Monitors Genset phase 1 of AC Frequency with optional configuration parameters and clear LCD status messages.
AC Phase Reversal	Monitors Genset AC for Phase reversal with optional configuration parameters and clear LCD status messages.
AC Loading	Monitors AC load as a percentage of full load capacity with optional configuration parameters. Overload units can be selected between KW and Amps.
AC Power Metering	Monitors AC power output (KW, KVA, KVAR, PF, KWH) with optional configuration parameters and clear LCD status messages.

## System LED Indications

Function	Description
Alarm	Red LED indication of system alarm.

## System LCD Displays

Function	Description
Setup menu	System configuration menus
Start Up	Clear step-by-step start up sequencing messages
Shutdown	Clear step-by-step shutdown sequencing messages
Transfer	Clear step-by-step load transfer messages

## Engine LCD Displays

Function	Description
Low oil pressure	Engine oil pressure low
High engine temperature	Engine temperature high
Low coolant level	Radiator water level low
Low fuel level	Engine fuel level low
Battery Voltage	Engine Battery Voltage and Droop voltage at last cranking cycle.

## Genset LCD Displays

Function	Description
Phase Voltages	Phase 1, 2 and 3 Voltages Line to Neutral and Line to Line.
Phase Currents	Phase 1,2 and 3 Currents
Phase Frequencies	Phase 1
AC Power Metering	Monitors AC power output (KW, KVA, KVAR, PF, KWH) with optional configuration parameters and clear LCD status messages.

## AC Inputs

Function	Description
3 Phase Genset AC Voltage	Genset AC voltages. 0 – 300V AC RMS
3 Phase Genset Current	Genset AC currents via external 5A CTs. 0 – 5 Amp input

## Analog Inputs

Function	Description
Lubrication Oil Pressure	Engine oil pressure sensor. (LOP) Current limited excitation for resistance sensing
Engine Temperature	Engine coolant temperature sensor (Air or Water). Current limited excitation for resistance sensing
Fuel Level	Engine fuel level sensor. Current limited excitation for resistance sensing

# KG934V1 User Manual



Analog 1	Yet to be defined Current limited excitation for resistance sensing
----------	--

## Digital Inputs

Function	Description
Auto Start / Stop Input	Auto start switch. Close to Common to activate.
Emergency Stop Input	Emergency stop switch. Close to Common to activate
Oil Switch Input	Oil pressure switch (LLOP). Close to Common to activate.
Canopy Temperature	Canopy temperature switch (HCT). Close to Common to activate.
Digital Input 1	User defined. Default = Not Used. Close to Common to activate.
Digital Input 2	User defined. Default = Not Used. Close to Common to activate.

## Special Inputs

Function	Description
Battery Voltage	Internal measurement of incoming DC supply.
Excitation Voltage	Internal measurement of battery charging alternator excitation voltage.
Low Water Level / Vbelt	Oscillating, AC coupled, Zero net current flow. Selectable between Low Water detection and V Belt broken.

## Outputs





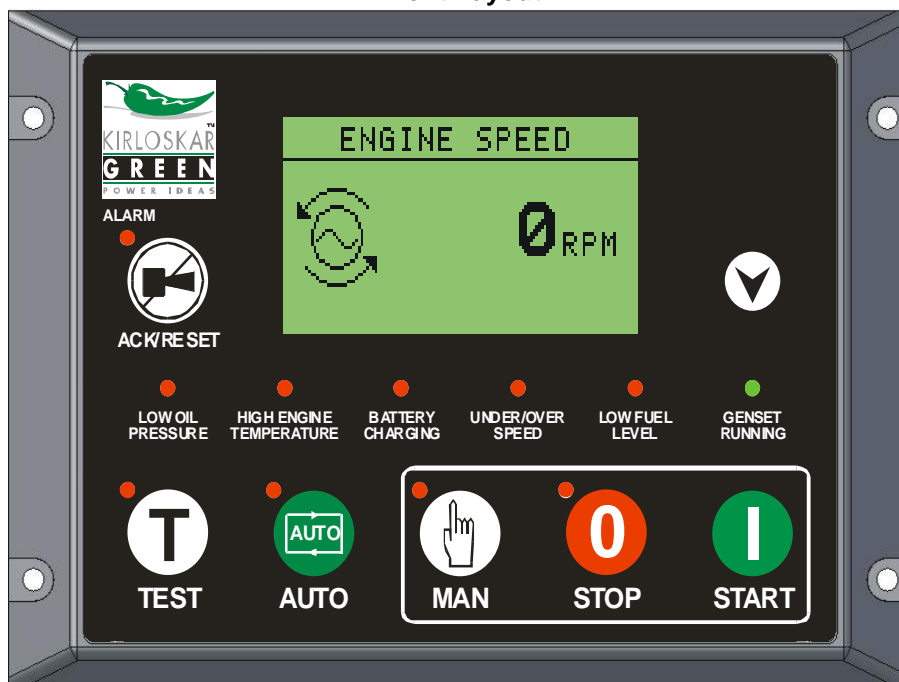

Function	Description
Excitation Output	Battery charging alternator excitation control (WL) Current controlled pulse
Fuel Output	Fuel relay coil control. Open drain 300mA overload protected
Crank Output	Crank relay coil control. Open drain 300 mA overload protected
Output 1 Default = Contactor A	ConA ConB
Output 2 Default = Contactor B	PreHeat Start Warn
Output 3 Default = Preheat	Fuel Pullin Crit Alarm
Output 4 Default = Off	Idle Control Start Fail Stop Fail Low Oil Stop HiTempStop Low Fuel Stop
	Open drain 300mA overload protected

## 4. Operation







### Front Layout



### Buttons

Button	Function Description
 <b>STOP</b>	<b>Manual Stop button / Menu Control</b> Used to initiate generator manual stop sequence. LED blinks during the stopping sequence. Used to select Off mode, when the engine is in standby. Used to clear alarms when the Genset was stopped for an alarm. <b>Used as system menu LEFT button</b>
 <b>MAN</b>	<b>Manual mode button</b> Used to select manual mode. Allows genset to be started only with start button press. LED indicates manual mode is active.
 <b>AUTO</b>	<b>Auto mode button</b> Used to select auto mode. Allows genset to be started only with Auto start input activation. LED indicates auto mode is active.
 <b>TEST</b>	<b>Test mode button / Menu Control</b> Used to select Test mode. Allows the genset to be started manually without changing the contactors. LED indicates test mode is active. <b>Used as system menu DOWN button.</b>
 <b>START</b>	<b>Manual Start button / Menu Control</b> Used to initiate generator manual start or test sequence. <b>Used as system menu RIGHT button.</b>
	<b>Screen Scroll button / Menu Control</b> Used to scroll LCD display to next screen. <b>Used to enter the menu system and accept changes.</b>
ALARM  <b>ACK/RESET</b>	<b>Alarm Acknowledge / Menu Control</b> Used to silence the sounder when the system is in alarm or has an active warning. Self resetting if enabled. LED indicates warnings and alarms. <b>Used as menu system UP button.</b>

## LEDs

LED	Function Description
 <b>ALARM</b>	<b>Alarm LED</b> Indicates warnings and alarm. Warnings are indicated by 1 blink per second. Alarms are indicated by 4 blinks per second.
 <b>LOW OIL PRESSURE</b>	<b>Low oil pressure LED (LOP)</b> Indicates low oil pressure warnings and alarms Warnings are indicated by 1 blink per second Alarm is on solid
 <b>HIGH ENGINE TEMPERATURE</b>	<b>High Engine Temperature LED</b> Indicates warnings and alarm Warnings are indicated by 1 blink per second Alarm is on solid
 <b>BATTERY CHARGING</b>	<b>Battery Charging LED</b> Blinking indicates under voltage, over voltage and charge failure On solid indicates no excitation while the engine is running Off indicates battery charging condition is OK
 <b>UNDER/OVER SPEED</b>	<b>Under / over speed LED</b> Indicates warnings and alarm Warnings are indicated by 1 blink per second Alarm is on solid
 <b>LOW FUEL LEVEL</b>	<b>Low Fuel Level LED</b> Indicates warnings and alarm Warning is indicated by 1 blink per second Alarm is on solid
 <b>GENSET RUNNING</b>	<b>Genset Running LED</b> Indicates the genset is running. Blinks to indicate the genset is starting or stopping

## Initial Power Up

On power up, the unit displays the Kirloskar logo, and turns on LEDs for a lamp test. The unit then displays the Serial number, Application Code and Firmware version. After the initialisation process is complete, the unit enters the mode selected in the setup menu and changes to READY.

## Ready

When the unit is in READY all measuring systems and display systems are turned on. The unit remains on for 1 minute and if the genset is not started in that time the unit goes into sleep mode to conserve battery power. In this mode the unit wakes periodically to check for any unusual conditions and if it finds none it goes back to sleep, otherwise it alarms accordingly. Any activity on the buttons immediately wakes the unit and the appropriate action is taken. In this state the engine and generator parameters are as expected for a stationary genset. If the conditions are not as expected, an appropriate warning or alarm is displayed on the LCD.

## Mode Selection

The unit may be operated in Auto, Manual, Test or Stop modes. The mode is selected by pressing the appropriate mode button. The mode is indicated on the LCD and the LED associated with the mode buttons.

The engine can be stopped with the Stop button in MANUAL, AUTO or TEST modes.

In MANUAL mode the unit responds only to the manual push button and may control A and B contactors if these options have been enabled.

In the AUTO mode, the unit responds to the autostart input or Remote Starts and controls A and B contactors.



In TEST mode the engine responds only to the manual start button and runs for a preset test time if configured. Contactors are not controlled.

In STOP mode the unit will enter low power mode, which turns off all LED's and sensor checking and will not start the genset.

To enter STOP mode, press the Manual Stop button when the unit is showing READY in the manual mode.

To exit STOP mode, press any button.

## Manual Mode Operation

### To start the genset

When the display is showing READY, press the start button momentarily to start the genset. Any warning or alarm conditions must be cleared before the genset can be started. The unit will perform the starting sequence as follows:

- **PREHEAT.**
  - The PREHEAT Output , if configured, will activate for the time specified.
- **FUEL-ON.**
  - If ETR (Energise To Run) fuel control is configured, the unit will control the fuel output and display FUEL ON and the proceeds to the CRANK state. If the Fuel Pull-in is configured it will be on for the first second of this sequence.
  - For ETS (Energise To Stop) the sequence does not activate the output and proceeds to the Crank sequence after a short delay.
- **CRANK.**
  - The Crank output is activated and the display shows 'Cranking' with a count down time.
  - The Crank output is deactivated when the unit has detected a speed signal above the crank disconnect speed specified in the settings. If selected, the crank will also terminate on achieving oil pressure or Battery charging alternator excitation has been achieved. This provides a secondary crank disconnect function to avoid over-cranking.
  - If the genset does not start, the LCD will show STOPPING, control the Fuel and Crank outputs accordingly, and return to READY. There are no retries with a Manual Start.
  - If the unit loses power due to battery voltage droop during cranking, and the engine fires, then on regaining adequate battery voltage, the unit will continue to allow the engine to run.
- **RUN UP.**
  - When the engine starts, the display shows RUN UP with a count down in seconds. This allows the engine measurement system to stabilise. Over speed and loss of speed signal are the only parameters checked during RUN UP.
- **WARM UP**
  - The display shows WARM UP with a countdown time. This allows the engine to stabilise at full speed before going on load. Oil pressure and Over-speed are monitored.
- **RUNNING**
  - The display shows RUNNING. Operating parameters are scrolled onto the display.
  - Engine temperature alarms have a hold-off period and will not prematurely cause engine shutdown if the engine has been previously run and has a high temperature.
  - Contactors, if configured, are controlled

## To stop the genset

Push the stop button briefly.

The unit will perform a stopping sequence as follows:

- **COOLDOWN**

- The display will show COOLDOWN with a count down time.
- The B contactor (if configured) is opened immediately and after a short delay contactor A (if selected) is closed.
- On expiry of the cool down timer the sequence continues to stop the engine.
- The cool down timer can be set to zero in the menu system to skip this sequence step.
- To truncate the cool down timer press the stop button again.
- The set can be returned to the running sequence by pressing the start button. The contactors return to place the genset on load again.

- **STOPPING**

- The display will show STOPPING with a countdown time.
- If ETR fuel control has been selected the Fuel output will be deactivated.
- If ETS fuel control has been selected then the Fuel output will be activated for the Max Fuel Time or until the engine stops. The stopping process will retry if the engine fails to stop the first time. Between stopping retries the Fuel output is deactivated for a short time to help overcome any jamming.
- The fuel output is controlled until the engine stops rotating and oil pressure decays. If the Oil Pressure has not decayed by the end of the 'Max Fuel Time', the fuel output is deactivated and the controller raises the alarm FAILED TO STOP. The speed must remain at zero and the oil pressure must be below the alarm set point for the 'Stop Time' before the engine is considered stopped.

- **READY**

- The engine has stopped and is ready to start again as required.

# KG934V1 User Manual



## 5. Display Operation

### When the genset is ready

When the genset is in standby and waiting for a start signal the following display is shown:

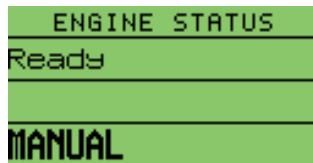

### When the genset is running

When the genset is starting and stopping, the display shows the state of the sequence together with the time remaining before the next state will commence.

Once the genset is fully running or if the genset is stopped and in 'READY', the running parameters are displayed. This includes generator and engine parameters simultaneously on separate displays. The unit sequentially scrolls through screens as shown below:

Splash Screen 1 Only shown at Power up	
Splash Screen 2 Only shown at Power up	
Product Identification Only shown at Power up Software Version KOEL Serial Number KOEL Application Code ID	
Sequence Status	
Engine Speed in RPMs	
Oil Pressure	
Engine Temperature	
Genset Battery Voltage Status	

# KG934V1 User Manual



<p>Fuel Status (If Enabled) The Hours remaining can optionally hidden</p>													
<p>Oil Temperature (If enabled)</p>													
<p>Engine Running Hours Total Engine Starts</p>													
<p>Genset Voltages Line to Neutral Line to Line</p>	<table border="1"> <thead> <tr> <th>GEN</th> <th>VOLTS</th> <th>L to L</th> </tr> </thead> <tbody> <tr> <td>R</td> <td>0</td> <td>-Y 0</td> </tr> <tr> <td>Y</td> <td>0</td> <td>-B 0</td> </tr> <tr> <td>B</td> <td>0</td> <td>-R 0</td> </tr> </tbody> </table>	GEN	VOLTS	L to L	R	0	-Y 0	Y	0	-B 0	B	0	-R 0
GEN	VOLTS	L to L											
R	0	-Y 0											
Y	0	-B 0											
B	0	-R 0											
<p>Genset Amps and Hz</p>	<table border="1"> <thead> <tr> <th>GEN</th> <th>AMPS</th> <th>HERTZ</th> </tr> </thead> <tbody> <tr> <td>R</td> <td>00</td> <td>00</td> </tr> <tr> <td>Y</td> <td>00</td> <td>00</td> </tr> <tr> <td>B</td> <td>00</td> <td>00</td> </tr> </tbody> </table>	GEN	AMPS	HERTZ	R	00	00	Y	00	00	B	00	00
GEN	AMPS	HERTZ											
R	00	00											
Y	00	00											
B	00	00											
<p>Genset KW and KVA</p>	<table border="1"> <thead> <tr> <th>GEN</th> <th>KW</th> <th>KVA</th> </tr> </thead> <tbody> <tr> <td>R</td> <td>+ 00</td> <td>00</td> </tr> <tr> <td>Y</td> <td>+ 00</td> <td>00</td> </tr> <tr> <td>B</td> <td>+ 00</td> <td>00</td> </tr> </tbody> </table>	GEN	KW	KVA	R	+ 00	00	Y	+ 00	00	B	+ 00	00
GEN	KW	KVA											
R	+ 00	00											
Y	+ 00	00											
B	+ 00	00											
<p>Genset KVAR and Power Factor</p>	<table border="1"> <thead> <tr> <th>GEN</th> <th>KVAR</th> <th>PF</th> </tr> </thead> <tbody> <tr> <td>R</td> <td>+ 00</td> <td>+10</td> </tr> <tr> <td>Y</td> <td>+ 00</td> <td>+10</td> </tr> <tr> <td>B</td> <td>+ 00</td> <td>+10</td> </tr> </tbody> </table>	GEN	KVAR	PF	R	+ 00	+10	Y	+ 00	+10	B	+ 00	+10
GEN	KVAR	PF											
R	+ 00	+10											
Y	+ 00	+10											
B	+ 00	+10											
<p>Genset Power Totals</p>	<table border="1"> <thead> <tr> <th>GEN</th> <th>Total</th> </tr> </thead> <tbody> <tr> <td>KW</td> <td>+ 00</td> </tr> <tr> <td>KVA</td> <td>+ 00</td> </tr> <tr> <td>KVAR</td> <td>+ 00</td> </tr> </tbody> </table>	GEN	Total	KW	+ 00	KVA	+ 00	KVAR	+ 00				
GEN	Total												
KW	+ 00												
KVA	+ 00												
KVAR	+ 00												
<p>Genset Average</p>	<table border="1"> <thead> <tr> <th>GEN</th> <th>Avg</th> <th>P. F.</th> </tr> </thead> <tbody> <tr> <td>L→N</td> <td>0</td> <td>+10</td> </tr> <tr> <td>L→L</td> <td>0</td> <td>Accumulated</td> </tr> <tr> <td>AMP</td> <td>00</td> <td></td> </tr> </tbody> </table>	GEN	Avg	P. F.	L→N	0	+10	L→L	0	Accumulated	AMP	00	
GEN	Avg	P. F.											
L→N	0	+10											
L→L	0	Accumulated											
AMP	00												
<p>Genset KWHours</p>													
<p>Contactor Status  This screen only appears if contactor out control has been configured.</p>													
<p>Any active warnings are shown here.  This is an example warning screen</p>													

The sequence returns to the “Sequence Status” screen.

## 6. Alarms and Warnings

In the event of abnormal operating conditions the unit will issue a warning of an impending alarm, then an alarm if a failure is detected. The genset is then shut down. The LCD shows an appropriate message indicating the nature of the condition. To draw operator attention to the condition the flashing general alarm LED is used.

In most cases, Warnings do not stop the genset and are self resetting. Alarms will normally stop the genset and require the operator to clear the alarm by pressing the Stop or Hooter button. The genset can not be started if an alarm exists.

Warnings are indicated by slow flashing of the alarm LED and displaying the appropriate message on the LCD as follows.

Alarms are indicated by fast flashing of the ALARM LED and displaying the appropriate message on the LCD.

Message	Function description
Oil Pressure Low	The oil pressure went below the alarm setpoint while running. Check oil level and replenish. Check for blocked oil filter.
Engine Temp High Coolant Temp High	The Engine / Coolant temperature went above the alarm setpoint while the genset was running. Check for over loading. Check cooling air flows, Check coolant level.
Canopy Temp High	The Canopy Temperature switch input was activated. Check cooling air flows. Check for overloading.
Fuel Level Low	The Fuel Level is below the alarm setpoint. The engine is stopped to prevent air and dirt infiltration to the engine. Replenish the fuel.
Battery Voltage High	The battery voltage went above the setpoint. High battery voltage usually indicates that the battery charging alternator has failed and it is producing a voltage which might damage the battery, control relays or the controller. Engine shutdown is recommended to minimise the risk of damage and fire.
Under Speed	The engine was running below the under speed setpoint. Check for overloading. Check fuel system.
Over Speed	The engine was running above the setpoint. Check governor system. Check power takeoff couplings.
Hirev Alarm	The speed signal indicates the engine is grossly over speed. Check Governor system.
Coolant Level Low	The radiator water level is below the required level. The water level needs topping up.
Start Fail	The engine has failed to start. Check Fuel supply, check battery condition, check air filters.
Stop Fail	The engine has failed to stop. Check stop solenoid, check rack operation.
Belt Broken	If the belt break detector has been activated. Check the belts
Oil-P Fault	The Oil Pressure sensor system is not functioning as expected. Check oil pressure sensor and associated wiring.
Eng-T Fault	The Engine Temperature Sensor is not functioning as expected. Check engine temperature sensor and associated wiring.
Fuel-L Fault	The Fuel Level Sensor is not functioning as expected. Check the Fuel Level Sensor and associated wiring.
Speed Fault	The Speed Sensing system is not working as expected. Check the associated speed sensor wiring and external influences such as poorly operating battery chargers and poorly filtered UPS systems connect to the load.

# KG934V1 User Manual



Message	Function description
Speed Detected	Speed signal is unexpectedly present. Check the associated speed sensor wiring and external influences such as poorly operating battery chargers and poorly filtered UPS systems connected to the load. Check electrical safety earthing systems. Check associated communications networks are isolated and not part of an unexpected earth loop.
Oil Detected	Oil Pressure is unexpectedly present. Check the Oil Pressure Sensors and associated wiring. Check the Oil filter system is not blocked. Check the engine is not running with a failed speed sensing system.
E-S Lock-out	The emergency stop input has been activated. Deactivate the emergency stop input, then press the stop button to clear this alarm.
AGF Phase Reversal	The generator has a phase reversal or the wiring is incorrect
AGF Loss GR Volts	Voltage on Generator Red Phase was lost
AGF Loss GY Volts	Voltage on Generator Yellow Phase was lost
AGF Loss GB Volts	Voltage on Generator Blue Phase was lost
AGF Low GR Volts	Voltage on Generator Red Phase is Low
AGF Low GY Volts	Voltage on Generator Yellow Phase is Low
AGF Low GB Volts	Voltage on Generator Blue Phase is Low
AGF High GR Volts	Voltage on Generator Red Phase is High
AGF High GY Volts	Voltage on Generator Yellow Phase is High
AGF High GB Volts	Voltage on Generator Blue Phase is High
AGF High Hz	Generator frequency is high
AGF Low Hz	Generator frequency is low

## 7. Load Transfer and Contactor Operation

The unit provides for both Mains and Generator contactor control even though in many applications this function will not be used, instead an MCB is used to switch the generator to and from the load. Contactor outputs, if selected, are controlled in both Manual and Auto operating modes.

The Mains contactor output can be setup to deactivate the Mains contactor in several ways

- Immediately when the start button is pressed or the autostart input is activated.
- A short delay after the start request
- When the genset is running and able to take load.

The Generator contactor output will activate only after the Mains contactor has opened and only when the genset able to take load. The timing is controlled by the XFR DELAY configuration setting.

If the genset was started by activating the Autostart input, then deactivating the input will move the sequence to the "Run On" sequence then to the "Cool Down" sequence. During cool down the Generator contactor output is deactivated and after a delay the Mains Contactor output is controlled to re-activate the Mains contactor.

## 8. Speed Sensing.

The unit can obtain speed information from one of four sources.

- Magnetic pickup unit (MPU)
- Battery charging flywheel magneto
- Generator output 50/60Hz if used for genset control (internally connected from GR)
- Battery charging alternator

### MPU

The magnetic pickup unit counts teeth on the flywheel and is mounted in the bell housing. It is important to ensure the gap between the MPU face and the teeth is 1mm to 2mm, as this distance greatly affects the output of the MPU. The unit requires a minimum of 3VRMS at low speed to ensure proper crank disconnect. Setup requires calculating the number pulses per 10 revolutions and the calculated number is then entered into the menu system "Cal Value".

Calculate: Number of Teeth x 10 = Speed Pulses Per 10 Revolutions.

Eg: 125 teeth x 10 = 1250.

Enter the number 1250.

### Generator

If the unit is used in a genset application the speed source can be the generator 50/60 Hz output and is connected internally within the unit from the AC input connectors. AC should NOT be connected directly to the speed MPU / Magneto input. For correct crank disconnect the generator must be providing a detectable output at low speed and therefore the voltage at 300 RPM must be greater than 40VRMS. This can be affected by the AVR and must be confirmed to provide suitable signals and timing for proper crank disconnect.

For setup the number of pulses per 10 revolutions must be calculated and entered into the menu system "Cal Value". The generator output frequency and standard RPM must be known.

Calculate Speed Calibration value as follows:

Cal Value = (Freq x 600) / RPM.

Eg: (50Hz x 600) / 1500 = 20

Enter the number 20.

## 9. Battery Charging Alternator Excitation

The battery charging alternator excitation system is implemented using a burst mode pulse system. This ensures reliable self-excitation while managing current consumption during standby, heat dissipation during fault conditions, and pulsing the battery-charging alternator prior to cranking for improved speed signal output.

During standby and Ready, the alternator excitation is pulsed once per minute to maintain some level of residual magnetism in the alternator but still maintaining minimum power consumption. On receiving a start signal, the unit pulses the alternator excitation input with a burst of 200mA pulses. The pulse width is dependent on the battery voltage. This pulse burst establishes a definite magnetic field in the battery-charging alternator prior to cranking. This ensures a significant speed-sensing signal is generated for crank disconnect sensing. The alternator excitation is turned off and the engine is cranked without the usual alternator burden loading the cranking process. This aids easier starting. When the engine has fired and is running, more 200mA pulse bursts are applied. Given the alternator is rotating at more than the 3000RPM the alternator will achieve self-excitation.

If self-excitation is not achieved this process will repeat for a few seconds before the excitation failed warning is given.

Alternator excitation may also be used as a secondary crank disconnect signal for the case where the speed signal has failed immediately the engine starts to run. This feature can be disabled if not required by setting "Excite Dis" to NO.



For systems where a battery-charging alternator is not fitted, turning off the excitation warning will disable the excitation system.

## 10. Battery Voltage Monitoring and Charging Detection

A battery is considered charged if (assuming a 12V system. x2 for 24V) its terminal voltage is above 13.1Volts. Typically a fully charged battery has a terminal voltage of 13.6V, above this and the battery is being overcharged. During cranking the large discharge current will reduce the battery terminal voltage below 12.5V and the battery cannot increase the terminal voltage again without the assistance of a charger. This sequence provides a useful mechanism to determine if a battery is being actively charged.

Many applications have a current meter to show charging current. Such meters provide very limited value as a good battery will recover its terminal voltage very quickly and then be maintained with a very low level of trickle current. This trickle current is usually too small a percentage of the current meters range to provide any useful information.

The unit constantly measures the battery terminal voltage and can detect proper charging and discharging performance. Voltage readings are taken and compared against an inbuilt voltage profile. If the battery terminal voltage falls outside the critical voltages for each action then a battery warning is indicated.

During standby, and particularly where an on line charger is not available, monitoring the health of the battery is vital. The unit regularly wakes and measures the battery voltage, if it falls below the set point a warning is issued to ensure the operator is aware of the need for battery recharging.

## 11. Set-up

In the factory environment the unit can be setup by the KOEL Cloning Utility or by the KOEL Windows setup utility. In the field, adjustments to the unit can be made using the buttons on the front panel.

The KOEL Windows setup utility and the KOEL Cloning options are detailed elsewhere and only the field adjustment method is discussed here.

To enter set-up, when the unit is showing "READY", press and hold the  button for 20 seconds.

When the unit enters set-up mode the LCD will show "Setup" and request a PIN number.



PIN Entry

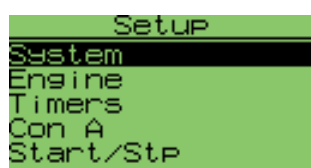

Column Selection

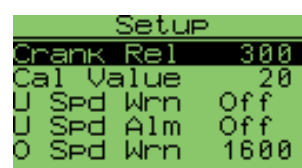

Item Selection

Entry to Setup mode can also be done while the unit is "RUNNING" to allow the Genset Amps and Voltages to be adjusted against the calibration standard (This should ONLY be done in the factory).

### Navigating in the setup menu

The setup menu comprises a range of columns where each column comprises of a list of items and each item has a range of settable values.

#### Column Headings are as follows:

System	Engine	Timers	Con A	Start/Stp	AC Setup	AGF Setup	Manual	I/O Config	Calibration	Comms	Stop Alm	Test IP
--------	--------	--------	-------	-----------	----------	-----------	--------	------------	-------------	-------	----------	---------

The  button (UP) is used to select the previous Column, Item, or to Increment a value.

The  button (DOWN) is used to select the next Column, Item, or to Decrement a value.



# KG934V1 User Manual



The **1** button (RIGHT) changes from Column to Item to Value editor.

The **0** button (LEFT) changes from Item to Column and Exit setup mode.

The **✓** button (ENTER) is used to accept Value changes and Start Setup mode.

Setup mode automatically terminates if no button is pressed for 60 seconds, or when you press the **0** button with the column headers list visible.

## System Column

Item	Range	Default	Description
Contrast	0 - 11	4	LCD Contrast
Disp Update	2 – 60 sec	3	Display Cycle Time, sets frequency of display updates. For manual scrolling press the <b>✓</b> button for the next measurement screen.
Disp Hold	5 – 60 sec	30	Display hold time. Sets the duration of display hold when the alarm button is pressed to halt the scrolling
PowerUp	Manual Last	Manual	PowerUp mode restore. On power restore places the unit in either Manual or the last used mode.
Wake Delay	0 – 720 min	0	The interval when the unit will power up and check inputs for alarms etc. When set to 0, the unit will never enter sleep mode.
LCDReverse	No Yes Cycle	Cycle	Controls the LCD Pixel Reverse No = LCD Always shows information with pixels on Yes = LCD Always shows background with pixels on Cycle = LCD alternates showing information with pixels on and showing the background with pixels on
Site ID	0 – 30000	0	Site Identifier. May also be used for asset numbering.
RemoteSetup	No Yes	No	Allows the unit to request remote units to enter setup mode
Defaults	No Yes	No	Setting to Yes will load all configuration items to their factory default values. Note: Engine RPM “Cal Value” calibration will be lost.

## Engine Column

Item	Range	Default	Description
Crank Rel	100 – 1000 Hz	300	Crank Disconnect Frequency
Cal Value	1 – 2500	20	RPM Calibration Value (Refer to Speed Sensing section)
U Spd Wrn	OFF 400 – 3600 RPM	OFF	Warning threshold for slow engine speed
U Spd Alm	OFF 400 – 3600 RPM	OFF	Alarm threshold for slow engine speed
O Spd Wrn	OFF 400 – 4000 RPM	1600	Warning threshold for high engine speed
O Spd Alm	OFF 400 – 4000 RPM	1650	Alarm threshold for high engine speed
Fuel Select	ETR ETS	ETR	Fuel Solenoid Type ETR (Energize To Run) ETS (Energize To Stop)
ETS Tries	1 - 2	2	<b>Note: This item is only displayed when Fuel Select = ETS (See Above)</b> Maximum Stop Retries for ETS Fuel Control.

# KG934V1 User Manual



Item	Range	Default	Description
ETS Rest	5 – 60 sec	5	<b>Note: This item is only displayed when Fuel Select = ETS (See Above)</b> Stop Retry Pause time for ETS Fuel Control. During this time the Fuel output is Off.
FuelMaxTm	5 – 600 sec	15	Maximum fuel solenoid activation time before a Failed to stop alarm is raised.
FuelLitreHr	1 – 600 Off Litre	4	Genset fuel consumption. Used to calculate the number of runtime hours remaining for current fuel level. When set to Off the Hrs is removed from the Fuel Screen.
FuelTotal	50 – 30000 Litre	1000	Total fuel tank volume. Used to calculate the litres of fuel remaining in fuel tank for current fuel level.
Fuel Type	Off COF 10 – 180 User	10 – 180	Fuel level sensor type. User = Curve uploaded by KOEL Setup utility
Fuel Alarm	Off 1 – 50 %	50	Fuel level alarm setpoint. Alarm output activates and engine is shutdown. When low fuel alarm is active engine start is inhibited.
Fuel Warn	Off 5 – 55 %	55	Fuel level warning setpoint. Note: This must be set above the Alarm setpoint.
Oil Type	10 – 180 User	10 – 180	Selects type of oil sensor being used. Dual station sensors can be used on same analog input. User = Curve uploaded by KOEL Setup utility
Oil Range	10 Bar	10	Used to select the oil sensor full scale in Bar
Oil Alarm	0.2 - 3.0 Bar	1.0	Low oil pressure alarm shutdown set point. Alarm output activates and engine is shutdown.
Oil Warn	0.2 – 3.1 Bar	1.5	Low oil pressure warning set point and engine continues to run. NOTE: This value must be set above the alarm setpoint
Oil Prot	Switch Sender Both	Switch	Oil protection sensor mode. Switch = Protection from switch input only Sender = Protection from analog input only Both = Combined protection
Oil Check	No Yes	Yes	Checks for oil pressure prior to cranking and raises the warning 'Oil Present' if oil pressure is present.
Oil Dis	No Yes	Yes	Yes = Uses the digital Oil Pressure input to disconnect the crank. This may be used as an auxiliary mechanism to disconnect the crank quickly when the speed source is slow to establish. No = Switch is only used for alarm if enabled (Oil Prot)
Oil Dis Dly	Off On	Off	Oil Pressure Disconnect delay. Used to delay the effect of the oil disconnect switch by 1 second for cold climatic conditions. Only configurable via the PC configuration Software.
LowWaterEn	Off On	On	Enables the Radiator Water Level Alarm. Must be disabled if the Water level is not monitored. When the ETemp Type = Engine this becomes the VBelt input
ETemp Delay	1 – 300 sec	30	Monitoring Delay time from engine starting before monitoring for high engine temperature. This is to allow the starting of a hot engine.
ETemp system	Water Engine	Water	Engine Cooling Temperature Source Water = Water monitoring Engine = Engine Air temperature monitoring

# KG934V1 User Manual



Item	Range	Default	Description
ETemp Type	COF TS150 User	TS150	Selects Engine temperature sensor type. COF = Switch: Close on Fault TS150 = VDO Sensor with FSD of 150°C User = Curve uploaded by KOEL Setup utility
ETemp Alarm	70 – 200 °C	98	High Engine temperature alarm shutdown set point. Alarm output activates. Engine is shutdown.
ETemp Warn	70 – 200 °C	95	High Engine temperature warning set point. Engine continues to run. NOTE: This value must be set below the alarm setpoint
OTemp Type	COF TS150 User	TS150	Selects Oil temperature sensor type via Analog input 1. COF = Switch: Close on Fault TS150 = VDO Sensor with FSD of 150°C User = Curve uploaded by KOEL Setup utility
OTemp Alarm	70 – 200 °C	98	High Oil temperature alarm shutdown set point. Alarm output activates. Engine is shutdown.
OTemp Warn	70 – 200 °C	95	High Oil temperature warning set point. Engine continues to run. NOTE: This value must be set below the alarm setpoint
OTemp Delay	1 – 300 sec	30	Monitoring Delay time from engine starting before monitoring for high Oil temperature. This is to allow the starting of a hot engine.
Lo Bat Vlt	OFF 9.5 – 24 Volts	10.0	Low Battery voltage level warning
Hi Bat Vlt	12 – 32 OFF Volts	15.0	High Battery voltage level warning
MaxBat Vlt	12.0 – 38.0 OFF Volts	18.0	Maximum Battery Voltage. If the Battery voltage exceeds this level then the engine is shut down. This is used to protect the battery from a failed alternator.
Charge Min V	OFF 10 – 28 Volts	13.1	The minimum battery voltage below which a “Low Charge Volts” warning is activated when the engine is running. This generally indicates an excitation failure or broken alternator belt.
Excite Warn	No Yes	Yes	Yes = charging alternator excitation failure warning enabled. No = charging alternator excitation failure warning disabled.
Excite Dis	No Yes	Yes	Yes = uses successful charging alternator excitation as a secondary crank disconnect signal to prevent over cranking. No = Excitation Disconnect function disabled.
Stop on Alarm	Off On	On	On = Engine protection functions are enabled. (Normal setting) Off = All protection shutdown mechanisms for the engine are disabled. Warnings and Alarms continue to be indicated.  Off should only be chosen for mission critical applications when shutdown is not permitted and the engine can run to destruction. This option is only settable using the KOEL Windows setup utility.

## Timers Column

Item	Range	Default	Description
PreHeat Time	0 – 60 sec	0	Time to turn on the PreHeating output prior to cranking 0 = Skip Preheat delay
Crank Time	1 – 30 sec	10	Maximum cranking time
Crank Rest	3 – 50 sec	10	Delay between cranking retries

# KG934V1 User Manual



Item	Range	Default	Description
Crank Tries	1 - 10	3	Crank retries. Manual and Test start sequencing will not retry.
Run Up	2 – 60 sec	3	Oil pressure, Temperature, Underspeed, and Overspeed, checking is disabled to allow these to stabilize during the starting process. Hirev is active to protect against a jammed governor.
Idle Up	0 – 60 sec	10	Engine Runs at low speed while the Idle Output is activated Under speed is not monitored
Warm Up	0 – 60 sec	10	Time for the engine to warm up after cranking. Under speed is not monitored.
Stop Time	3 – 600 sec	15	Time to allow large engines to completely stop rotating and oil pressure decline when stopping. During this time if Energize to Stop option is chosen, the fuel solenoid will activate up to the Fuel Max Time.
Stop Rest	2 – 20 sec	6	The time that oil pressure and speed signals are absent for before the unit considers the engine to be stopped.
Test Time	0 – 720 min	0	The duration to run the Engine for when started in Test mode. 0 = Run until the user stops the engine
Sounder Time	0 – 600 sec	0	0 = Sounder remains on indefinitely until acknowledged Value = Sounder maximum time is the value in seconds.
Maintenance	OFF 50 – 1000 hours	250	Hours between Maintenance Requests

## Contactora A Column

Item	Range	Default	Description
Unload	Imed Delay Run	Imed	Contactora A unload mode. Imed = Unloads contactora A at the beginning of the Start Delay Delay = Unloads contactora A after a delay (see next item) or when the genset is ready for load, (whichever is the sooner) Run = Unloads contactora A when the genset is ready for load
Unload Dly	3 – 999 sec	5	<b>Note: Only displayed if Unload is set to Delay</b> Delay for Delayed Unload mode (see above)
Xfr Delay	0 – 10 sec	5	Delay time between break and make operations for A to B and B to A contactora transfer control.

## Start/Stop Column

Item	Range	Default	Description
Start Delay	0 – 600	2	Autostart Delay Time. The time between the detection of an Autostart activation and the initiation of starting. Start time units are set in the next item.
Start Units	Ses Min	SEC	Units for the Autostart delay time Sec = Seconds Min = Minutes
StartRestore	1 – 600 sec	5	Selects the time for which the Autostart has to be restored before the start delay timer is reset and starting aborted.
Start Warn	0 – 30 sec	2	Prestart warning time. If an output has been assigned to a Start Warning function, then it will turn on for this time period before a start occurs.
Run On	0 – 3600 sec	60	Run On Time. During run on reactivation of Autostart input will return the engine to running state. The generator remains on load.
Cool Down	0 – 3600 sec	60	Cool Down Time. Used to cool the turbo and alternator as required. The generator is off load.

# KG934V1 User Manual



Item	Range	Default	Description
Idle Down	0 – 360 sec		Engine is run and low speed prior to stopping. The Idle output is on during this time.

## AC Setup Column

Item	Range	Default	Description
VPhases	1 – 3	3	1: = 1 Phase Alternator system. 2: = 2 Phase Alternator system. 3: = 3 Phase Alternator system.
IPhases	1,3	3	Selects the number of CTs used. When the load is balanced between phases, and cost minimisation is important, a single CT for phase 1 may be used.
CT Ratio	1 – 2000	12	Selects the CT ratio
PhaseRev	Off On	On	Enables genset phase reversal to generate an alarm and shut down the engine.

## AGF Setup Column

Item	Range	Default	Description
Lo Volt Trip	60 – 240 Volts	180	The minimum voltage below which the Genset is shut down
Lo Volt Dly	0 – 30 Sec	3	Time before the alarm will react to Low voltage
Hi Volt Trip	110 – 300 Volts	275	The maximum voltage above which the Genset is shut down
Hi Volt Dly	0 – 30 Sec	3	Time before the alarm will react to high voltage
Lo Hz Trip	Off 30 – 60 Hz	44	The minimum frequency below which the Genset is shut down. This is only checked while the engine is Running on load.
Lo Hz Dly	0 – 30 sec	3	Time before the alarm will react to low frequency.
Hi Hz Trip	50 – 70 Hz	56	The maximum frequency above which the Genset is shut down.
Hi Hz Dly	0 – 30 Secs	3	Time before the alarm will react to high frequency.
O/Load KW	Off 5 – 6553 KW	30	Maximum KW above which the Genset will shut down
O/Load KW Tm	5 – 60 Sec	10	Time before the alarm will react to KW Overloading
O/Load Amp	Off 5 – 6553 Amps	50	Maximum KW above which the Genset will shut down
O/Load Amp Tm	5 – 60 Sec	10	Time before the alarm will react to Amps Overloading
LoadImbal	Off 5 – 6553 Amps	10	Maximum difference between Amp phases above which will shut down the engine
LoadImbal Tm	5 – 60 Sec	10	Time before the alarm will react to Load Imbalances

## Manual Column

Item	Range	Default	Description
Transfer	No Yes	Yes	Enables Transfer of the load to the Genset in manual mode.

# KG934V1 User Manual



## I/O Config Column

Item	Default	Description
O/P1	ConA	Selectable Digital Output Function from one of the following: ConA = Contactor A Control ConB = Contactor B Control PreHeat = Control Preheater prior to cranking Start Warn = Turn on output to warn of an impending start Fuel Pullin = Controls the high current coil on the Starter motor Crit Alarm = Turn on output when the is shut down for alarm Idle Control = Start and stop engine with Idle Output Start Fail = Turns on when the Engine failed to start Stop Fail = Turns on when the engine failed to stop Low Oil Stop = Turns on when the engine stopped for low oil HiTempStop = Turns on when the engine stopped for Hi ETemp Low Fuel Stop = Turns on when the engine stopped for low Fuel
O/P2	ConB	
O/P3	PreHeat	
O/P4	Off	
I/P1	Off	Selectable Digital Input Function from one of the following: Trip = Stop the engine when sensor is activated Fire Alarm = Stop the engine if fire alarm input is activated Bypass = prevent engine form starting while activated Door = Raise a warning while input is activated
I/P2	Off	

## Calibration Setup Column

Item	Range	Default	Description
Clear Cal	No Yes	No	Set this to Yes to reset unit to KG default calibration
Mains VR Adj	+/-10Vrms	0Vrms	Allows KEIL factory to adjust the Main Red phase offset
Mains VY Adj	+/-10Vrms	0Vrms	Allows KEIL factory to adjust the Main Yellow phase offset
Mains VB Adj	+/-10Vrms	0Vrms	Allows KEIL factory to adjust the Main Blue phase offset
Genset VR Adj	+/-10Vrms	0Vrms	Allows KEIL factory to adjust the Genset Red phase offset Note: The engine needs to be running to adjust this
Genset VY Adj	+/-10Vrms	0Vrms	Allows KEIL factory to adjust the Genset Yellow phase offset Note: The engine needs to be running to adjust this
Genset VB Adj	+/-10Vrms	0Vrms	Allows KEIL factory to adjust the Genset Blue phase offset
Amps IR Adj	+/-10Vrms	0Vrms	Allows KEIL factory to adjust the Amps Red phase offset
Amps IY Adj	+/-10Vrms	0Vrms	Allows KEIL factory to adjust the Amps Yellow phase offset
Amps IB Adj	+/-10Vrms	0Vrms	Allows KEIL factory to adjust the Amps Blue phase offset

Notes:

1. These items are intended to allow KEIL factory to make adjustments for variations in CTs and external voltage measuring points.
2. The engine needs to be running to adjust Genset related values.

## Comms Setup Column

Item	Range	Default	Description
Comms ID	1 - 240	134	Comms Address. Required for remote communications
Baud Rate	1200 57600	9600	Comms Port Baud Rate 1200, 2400, 4800, 9600, 19200, 38400, 57600
Data Bits	7 - 9	8	Number of Data Bits
Parity	Even Odd None	None	Parity Select
Stop Bits	1 or 2	1	Number of Stop Bits
UART Mode	None Modem LAN	None	RS232 Handshaking Mode None = No RTS/CTS control. 3 wire connection. Modem = Uses RTS/CTS flow control. 5 wire connection. LAN = Allows connection to an RS485 adapter. EG: KG18

# KG934V1 User Manual



## Notes:

1. Unit has basic communications to allow factory testing and validation.
2. Allows the unit to be connected to external KG modules for enhanced communication functions.

## Test I/P Column

Item	Range	Description
I Auto Start	Off, Act	Displays the status of the Auto start input for testing
I Emer Stop	Off, Act	Displays the status of the Emergency Stop input for testing
I Oil Switch	Off, Act	Displays the status of the Oil Switch input for testing
I Fire	Off, Act	Displays the status of the Fire Alarm input for testing
I Door	Off, Act	Displays the status of the Door input for testing
I By Pass	Off, Act	Displays the status of the By Pass input for testing
I Trip	Off, Act	Displays the status of the Trip input for testing
I HCT	Off, Act	Displays the status of the HCT input for testing

## Stop Alarm Log Viewer Column

This log contains the last 10 reasons that the Engine was stopped  
Stop Alarm log history items cannot be deleted or changed except by using the KOEL Windows setup utility program.



# KG934V1 User Manual



## 12. Unit General Specifications

Feature	Specification
Overall Dimensions	180 x 126 x 51mm
Mounting Hole	155 x 117mm
IP rating	IP56 front, IP20 rear
Supply Voltage	8 V to 36V DC Nominal Automotive
Operating Temperature	-20 to +70°C
Storage Temperature	-20 to +70°C
Relative Humidity	95% non condensing
Supply Current	Standby < 10mA Running 70mA
AC Voltage Range	L-N = 350VRMS.
AC Frequency Range	40 – 70Hz
CT current range	0 – 5A + 20% Overload
Overall Accuracy	Class 1
Digital Output Rating	Open Drain Relay Coil Driver. 300mA 32VDC max. Short Circuit protected.
Digital Input Rating	Whetting current 10mA at 12 V DC. DC input protection for +/- 30V DC Transient Protected.
Analog Input Rating	Current limited outputs approx 15mA or less as required by sensors/ Short circuit and reverse voltage protected.
Input Reference	DC- / 0V / Common
Displayed Speed Range	0 – 4000 RPM
Engine Hours	0 – 99999.9 Hours
Kilo Watt Hours	0 – 999999.9 KWH
Oil Pressure Sensor Type	Switch: Close on fault Resistive 10 to 180 Ohms, User Curve
Oil Pressure Ranges	5.0, 7.5, 10 Bar
Engine Temperature Sensor Type	Switch: Close on fault Resistive (NTC)
Engine Temperature Ranges	VDO 150°C, User Curve
Canopy Temperature Sensor Type	Switch: Close on fault
Fuel Level Sensor Type	Switch: Close on fault Resistive: 10 to 180 Ohms, User Curve
Battery Volts Measurement	8 to 36 Volts
Set-up and Adjustment	All features may be adjusted using set-up buttons and LCD menu or via a PC Windows based utility
Terminations	Amp DUAC / Molex Mini Fit JNR
Testing	Environmental Tests: IEC68 Part2 EMC Compliance: EN50081-1, EN50081-2, IEC6100-4-3 Electrical Safety AS 3100 and AS 3260



# KG934V1 User Manual



## 13. Inputs Electrical Specification

Input	Type	Comment
Battery + Volts	Power	Nominal 12VDC or 24VDC or Station Battery Supply Range 6-36VDC
0V Common	Power	0VDC, Common
Fuel Level Sensor	Analog/Digital	Suitable for either resistive or switch C.O.F senders
Coolant Temperature Sensor	Analog/Digital	Suitable for either resistive or switch C.O.F. senders
Canopy Temperature	Digital	Suitable for switch input. Connect to 0V = Active
Oil Pressure Sensor	Analog	Suitable for either resistive or switch senders. Optionally for protection or display only.
Low Water Level	Special	Suitable for probe or switch input. Open Circuit = No water present
Autostart	Digital	Suitable for switch input. Connect to 0V = Active
Emergency Stop	Digital	Suitable for switch input. Connect to 0V = Active
Oil Pressure Switch	Digital	Used for backup Oil Pressure protection.
Digital Input 1	Digital	Suitable for switch input. Connect to 0V = Active
Digital Input 2	Digital	Suitable for switch input. Connect to 0V = Active
Excitation	Internal	High Impedance input
Battery Voltage	Internal	High Impedance
GR	Voltage	Generator Red Phase Volts. Max 350VRMS
GY	Voltage	Generator Yellow Phase Volts. Max 350VRMS
GB	Voltage	Generator Blue Phase Volts. Max 350VRMS
GN	Voltage	Generator Neutral
CTR	Amps	Red Phase CT Amps. (S2) 5A RMS. Max 6A for 1 second
CTY	Amps	Yellow Phase CT Amps (S2). 5A RMS. Max 6A for 1 second
CTB	Amps	Blue Phase CT Amps (S2). 5A RMS. Max 6A for 1 second
CTCom	Amps	Common connection for CT S1 terminals. Do not connect to earth.
SPA	Voltage	Speed A magnetic pickup input 3V – 70V peak at >500 to 10KHz Speed A Battery Alternator input 2V – 70V peak at 20Hz to 1KHz
SPB	Voltage	Speed B magnetic pickup input 3V – 70V peak at >500 to 0KHz Speed B Battery Alternator input. Connect to common.
SPCom	Voltage	Speed Common 0VDC

## 14. Outputs Electrical Specification

Output	Type	Comment
Charger WL	Current	200mA burst mode pulsed current controlled output. Used to provide the battery charging alternator with excitation current.
Stop / Fuel Relay	Open Drain	300mA Open Drain protected coil drive. Max 36VDC This output is used to control the fuel solenoid interposing relay and can be set for either Energise to Run or Energise to Stop functionality. It is recommended that the fuel relay is located near to the fuel control solenoid. This position removes the need for high current wiring to the control box and thus leads to lower cost.
Crank Relay	Open Drain	300mA Open Drain protected coil drive. Max 36VDC This output is used to control the interposing crank relay coil. The crank relay should be sized for the crank contactor current. It is recommended that the crank relay is located near to the starter motor. This position removes the need for high current wiring to the control box and thus leads to lower cost.
Output 1 to Output 4	Open Drain	300mA Open Drain protected coil drive. Max 36VDC These outputs can be configured for various functions. They are intended to drive interposing relays and not the particular loads directly.

# KG934V1 User Manual

## 15. Installation and Wiring

**NB: The unit is a complex electronic device and caution should be taken to ensure correct wiring before power is applied.**

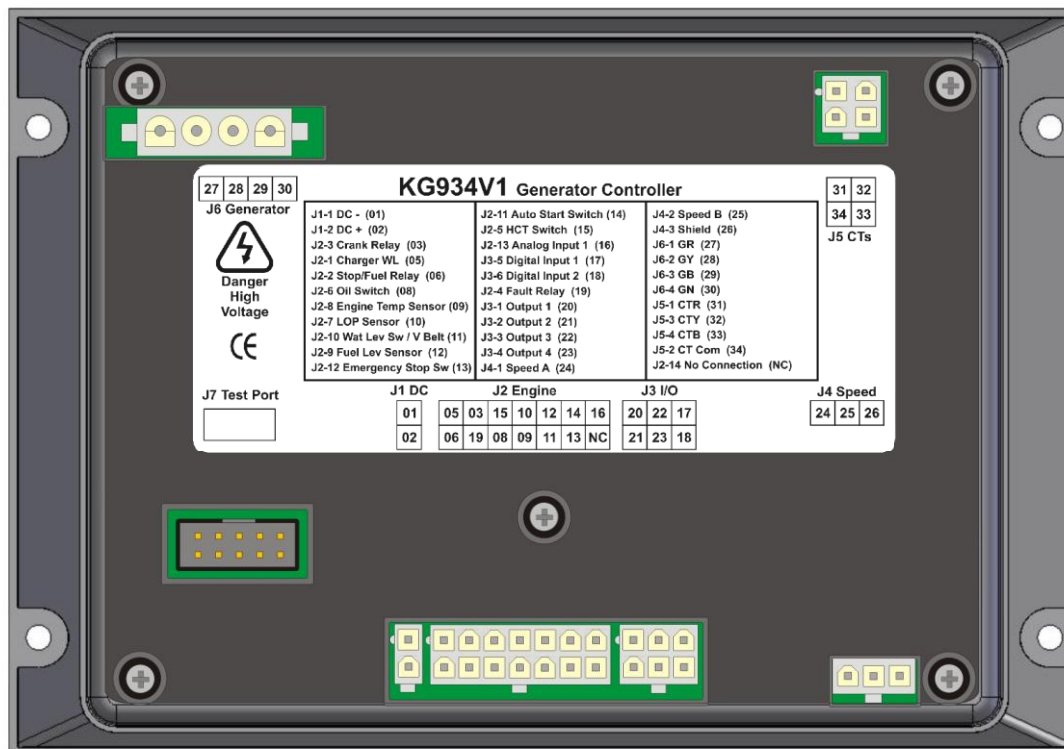

The unit is fitted with 2, 3, 6 and 14 way Molex Minifit or equivalent socket connectors for which mating plugs can be selected from the Molex, Tyco/Amp PE, or TPK 5566 range.

The unit is also fitted with 4 way Mate-N-Lok or equivalent socket connectors for which mating plugs supplied by Tyco Electronics or equivalent can be used.

The majority of unit wiring is low current for which 0.75mm<sup>2</sup> wire is sufficient. This excludes the CT wires (CTR, CTY, CTB, CTCOM) for which 1.5mm<sup>2</sup> wire should be used.

### Connector Details

Connector Assignment	Pin	Wire	Name	Function
<b>J1: DC Power Supply</b> 	J1-1	01	DC -	Battery – Supply. 0V, Common. This connection must be made directly to the engine crankcase for lowest electrical noise. This connection must not have currents other than the controller currents flowing and must be used exclusively for the controller.
	J1-2	02	DC +	Battery + Supply. This connection must be made directly to the positive terminal of the battery for best performance. Do not make this connection to the positive terminal on the Starting Motor.

# KG934V1 User Manual

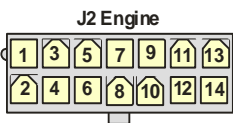
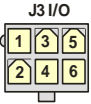
Connector Assignment	Pin	Wire	Name	Function
<b>J2: Engine</b> 	J2-1	05	Charger WL	Battery Charging Alternator Excitation. WL point
	J2-2	06	Stop/Fuel Relay	Coil Drive for the Fuel Control Relay. Switches to common
	J2-3	03	Crank Relay	Coil Drive for the Crank Relay. Switches to common
	J2-4	19	Fault Relay	Coil Drive for the Fault Relay. Switches to common
	J2-5	15	HCT Switch	High Canopy Temperature Switch Input. Activate by switching to common
	J2-6	08	Oil Switch	Low Oil Pressure Switch Input. Activate by switching to common
	J2-7	10	LOP Sensor	Lube Oil Pressure measuring input. Measures Resistance.
	J2-8	09	Engine Temp Sensor	Engine Temperature measuring Input. Measures Resistance.
	J2-9	12	Fuel Lev Sensor	Fuel Level sensor Input. Measures Resistance.
	J2-10	11	Wat Lev Sw V Belt	Water Level or V Belt sensing Input. Oscillating Output/Input system. Connects to water level probe, water level switch or V Belt broken switch
	J2-11	14	Auto Start Switch	Auto Start Input. Activate by switching to common. Starts the DG
	J2-12	13	Emergency Stop Sw	Emergency Stop Switch. Activate by switching to common. Stops the DG
	J2-13	16	Analog Input 1	Analog Input 1. Measures Resistance. Used for the Oil Temperature Sensor.
	J2-14	NC	No Connection	Analog Input 2. Measures Resistance. No hardware fitted and No Functions assigned to this input at this time.
<b>J3: Input / Output</b> 	J3-1	20	Output 1	Coil Drive for an external control Relay. Switches to common. Configurable for various functions
	J3-2	21	Output 2	Coil Drive for an external control Relay. Switches to common. Configurable for various functions
	J3-3	22	Output 3	Coil Drive for an external control Relay. Switches to common. Configurable for various functions
	J3-4	23	Output 4	Coil Drive for an external control Relay. Switches to common. Configurable for various functions
	J3-5	17	Digital Input 1	Digital Input 1. Activate by switching to common. Configurable for various functions. See Menu Options above.
	J3-6	18	Digital Input 2	Digital Input 2. Activate by switching to common. Configurable for various functions. See Menu Options above.

# KG934V1 User Manual

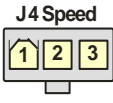
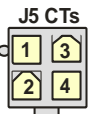
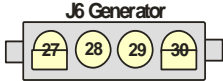
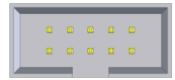
Connector Assignment	Pin	Wire	Name	Function
<b>J4: Speed</b> 	J4-1	24	Speed A	Frequency sensing Input for speed sensors. Connects to MPU (MPU +), Battery Charging Alternator (W), or Magneto. <b>Note: Not suitable for connecting to the Generator Output. Instead Use the Generator Voltage Input GR</b>
	J4-2	25	Speed B	Return connection for the MPU. Connect to (MPU -)
	J4-3	26	Shield	Common connection for the MPU shield.
<b>J5 Current Transformers</b> 	J5-1	31	CTR	Connects to the external Red Phase CT terminal S2. The load wire must pass through the CT in the direction of the CT arrow.
	J5-2	34	CT Com	Connects to the external CT's commoned S1 terminals.
	J5-3	32	CTY	Connects to the external Yellow Phase CT terminal S2. The load wire must pass through the CT in the direction of the CT arrow.
	J5-4	33	CTB	Connects to the external Blue Phase CT terminal S2. The load wire must pass through the CT in the direction of the CT arrow.
<b>J6: Alternator AC Input</b> 	J6-1	27	GR	Connects to the Generator Red Phase output.
	J6-2	28	GY	Connects to the Generator Yellow Phase output
	J6-3	29	GB	Connects to the Generator Blue Phase output
	J6-4	30	GN	Connects to the Generator Neutral output, where available.
<b>J7: Test Port</b> 	J7		Test Port	Programming / Validation / Test Port. NB: Connect ONLY KG expansion modules to this port.

**NB: The unit is a complex electronic device and caution should be taken to ensure correct wiring before power is applied.**

## 16. Trouble shooting

The unit displays the following messages when an alarm occurs. Alarms shut down the engine, set the alarm output and flash the alarm indicator. The alarm indications can be cleared after the genset has stopped, by pressing the stop button. The hooter can be silenced with the Hooter Button.

### Alarm Messages

Message	Cause
Low Oil Pressure	Oil pressure has not reached the Oil Alarm set point (Oil Alarm) at the end of the run up time or has dropped below this value when the engine is running.
Low Fuel Level	Fuel level is less than the minimum value set point.
High Engine Temp High Water Temp	Engine temperature has exceeded the high temperature set point. The temperature icon turns on. Either message may also be shown depending on temperature system setup.
High Canopy Temp	Canopy temperature switch was activated.
Low Water Level	Water Level has gone below the water sensor.
Under speed	Engine speed has dropped below the under speed set point.
Over speed	Engine speed has exceeded over speed set point.
High Rev	Engine has exceeded safe operating speed.
No Speed Signal	Engine has lost speed signals while running.
Start Failure	The engine has failed to start.
Stop Failure	The engine has failed to stop.
E-S Lock out	The emergency stop input has stopped the engine.
Oil Pressure Flt	The unit has detected that the Oil Pressure sender has become open circuit. Normally this indicates a faulty sender or broken wiring. This will only shut down when the Oil System is set to Sender.
Engine Temp Flt	The unit has detected engine temperature has not risen above 50 degrees after 5 minutes of running or the temperature. This indicates a faulty temperature sender or damaged.
Oil Temp Flt	The sensor connected to Analog 1 input is faulty or open circuit.



The following warning messages indicate potential problems. When a warning occurs, the message associated with the warning is displayed. Warnings clear automatically when the warning condition is cleared.

### Warning Messages

Message	Cause
No Excitation	Excitation voltage is low when engine is running. This indicates a probable charging fault or the alternator belt has broken.
Low Charge Volts	Battery Voltage is below the charging voltage setpoint when the engine is running. Indicates that the alternator is not charging the battery.
Under Voltage	Battery Voltage is below the low battery setpoint.
Over Voltage	Battery Voltage is above the high battery volts setpoint. This may be due to a faulty regulator or battery charger.
Oil Lock Out	The unit has detected that the oil pressure is above the oil pressure alarm setpoint with the engine not running. This warning prevents the engine from attempting to crank with the engine potentially running. This may be due to a faulty oil sender or a very tight engine. This warning is disabled if Oil Pressure Check before Cranking is set to Off.
Tacho Lock Out	The unit has detected that a speed signal is present with the engine not running. This warning prevents the engine from attempting to crank with the engine potentially running. This warning can sometimes be caused by ripple generated by mains powered battery chargers.
Excite Lock Out	The unit has detected that Excitation is present with the engine not running. This warning prevents the engine from attempting to crank with the engine potentially running. This warning can sometimes be caused by ripple generated by mains powered battery chargers.
AutoStart On	The unit has detected an Autostart signal when not in auto mode, indicating the engine needs to be started in Auto mode.
Low Oil Pressure	The Oil Pressure has dropped below the Oil Pressure Warning set point while the engine is running. The Oil Pressure Icon is lit.

# KG934V1 User Manual



High Engine Temp High Water Temp	Engine Coolant temperature has exceeded the high temperature warning set point after the Temperature monitoring delay has expired.
High Canopy Temp	Canopy Temperature was activated after the Temperature monitoring delay has expired.
Low Fuel Level	Fuel level is less than the warning set point.
Fuel Level Flt	The unit has detected that the fuel sender is open circuit. This is only a warning, and will not shut down the engine
No Speed Signal	A speed signal could not be detected after the engine had started
Maintenance	The time since the last maintenance has exceeded the maintenance time. The alarm output is not activated for this warning. The warning is cleared by pressing and holding the  button for 30 seconds. If the engine maintenance is carried out prior to the timer expiring, pressing the  button for 60 seconds will reset the timer.

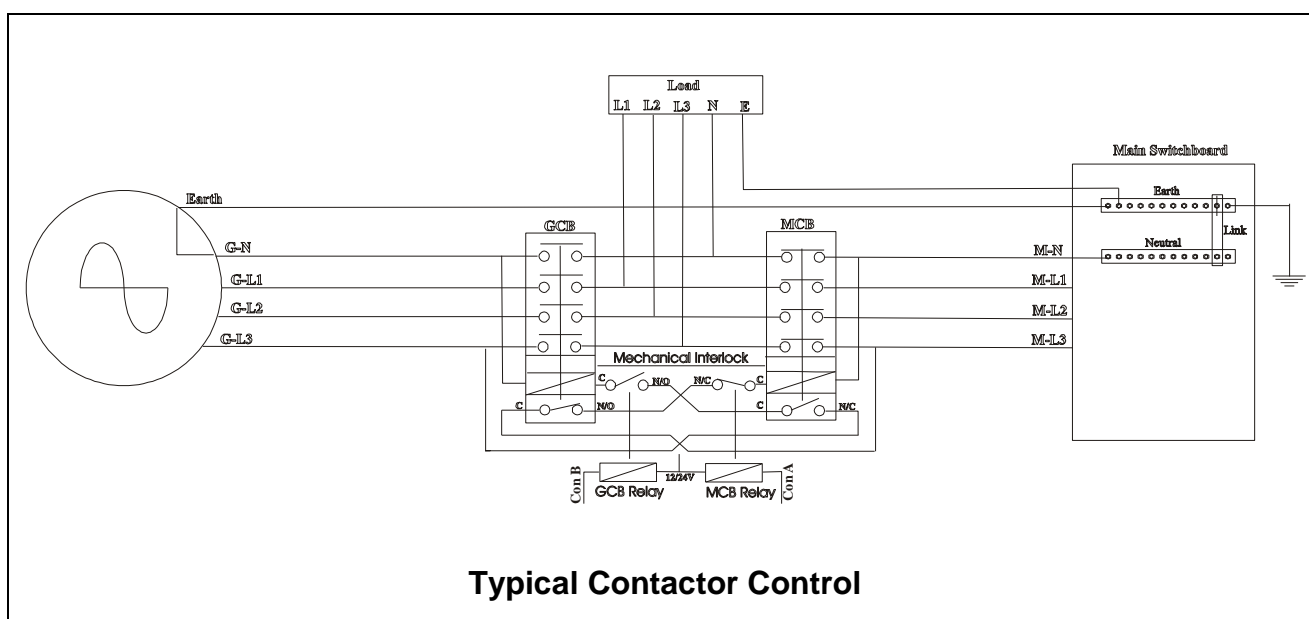

Enriching Lives

## KIRLOSKAR OIL ENGINES LIMITED

Laxmanrao Kirloskar Road, Khadki, Pune-411 003, India.

Tel : +91(20) 2581 0341

Fax: +91(20) 2581 3208/ 2581 0209

www.kirloskar.com

Part No. 2H.831.04.0.00